

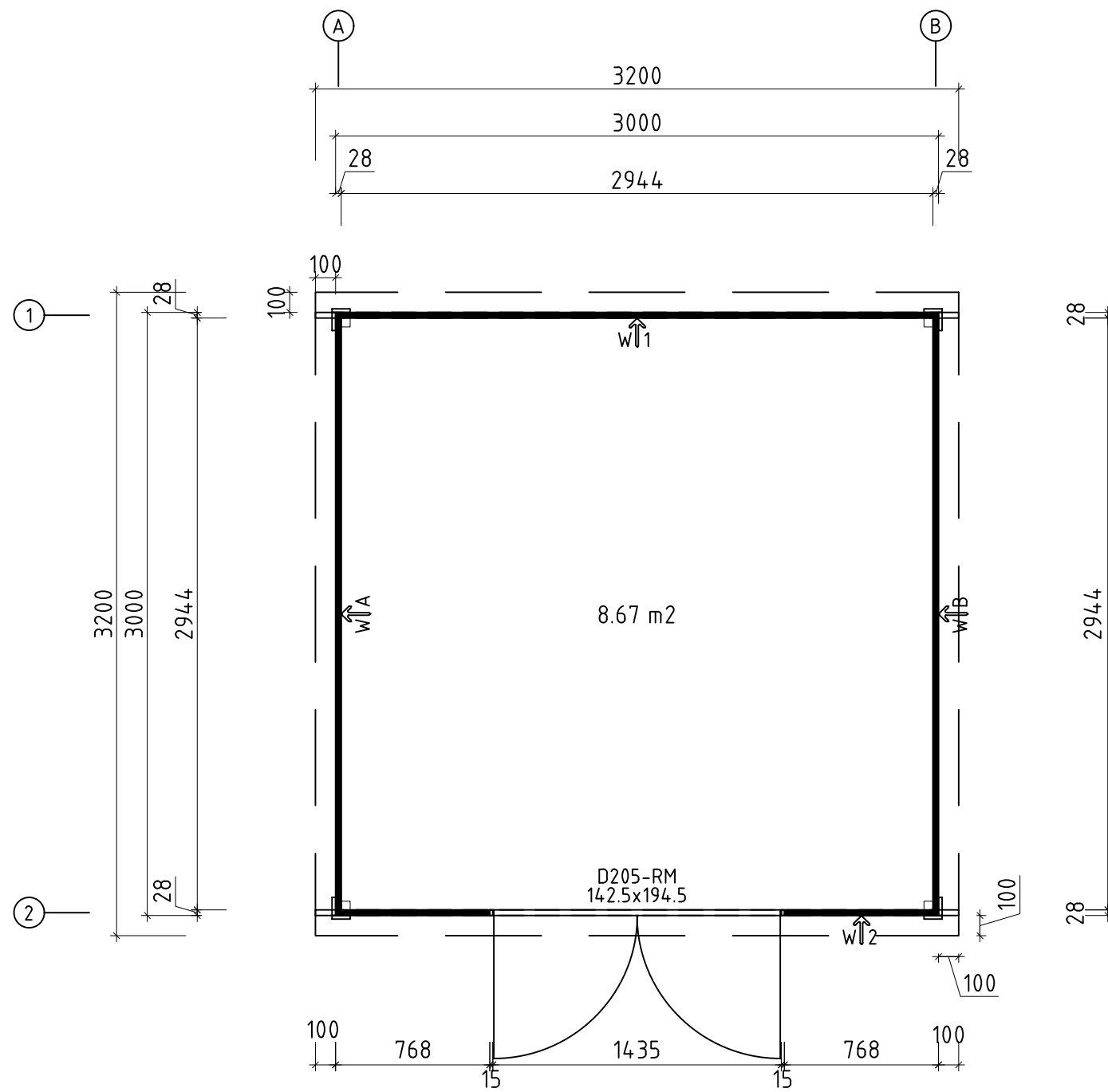

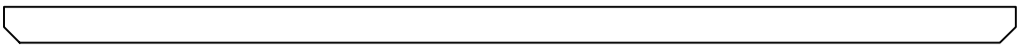

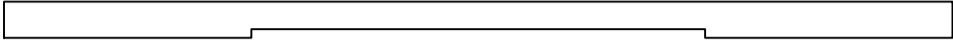

Name	VS28_0044 Zambezi7 300x300_28		
Zeichnung/Drawing	3D		
Profil/Profile	2.8x11.4	Datum/Date	26.01.2024

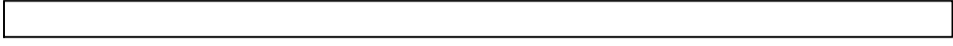

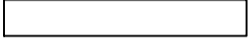
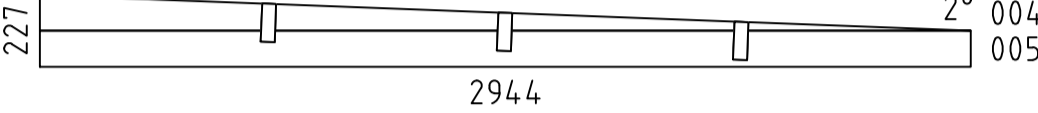
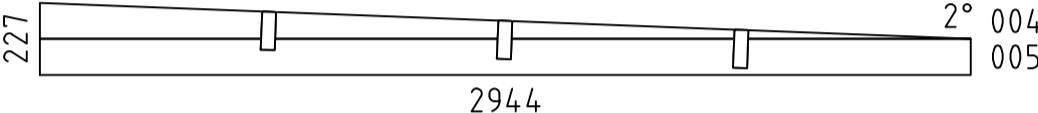
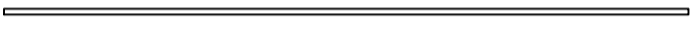
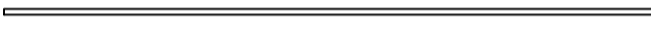
Q1- Qualitätsklasse für Fenster und Türen/  
Quality class for windows and doors

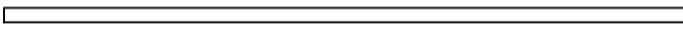
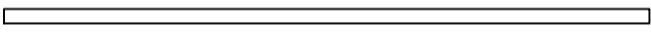
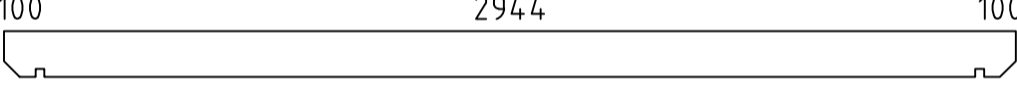
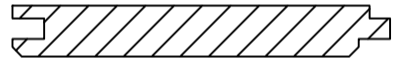
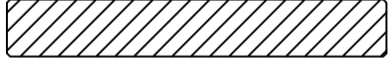
Name	VS28_0044 Zambezi7 300x300_28		
Zeichnung/Drawing	Grundplan_Plan		
Profil/Profile	2.8x11.4	Datum/Date	26.01.2024

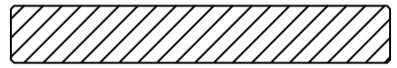
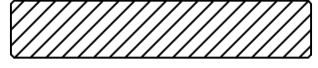
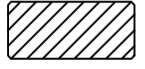
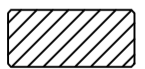
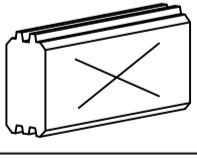
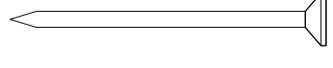
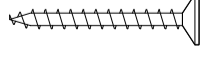
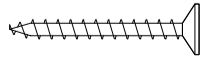
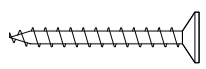
Pos	Teileliste/Specification VS28_0044 Zambezi7 300x300_28		Stck Pcs.	Profil Profile (mm)	Länge Length (mm)	
001			2	28x114	3200	
002			1	28x114	3000	
003			17	28x114	3000	
005			34	28x114	2944	
006			34	28x114	767	
WA-1			1			
WB-1			1			
LE2		LEISTE - LATH	✓	4	95x18	2165
LE1		LEISTE - LATH	✓	4	95x18	2052
LE3		LEISTE - LATH		2	15x28	1938
EP2		ECKPFOSTEN - CORNER POST		2	45x45	2156
EP1		ECKPFOSTEN - CORNER POST		2	45x45	2042
PF1		PFETTEN - PURLINS		3	44x145	3200
	DACHBRETTER - ROOF BOARDS			29+1	113x16	3202
G02-1	GIEBELBRETTER - GABLE BOARDS 18x120		✓	2	18x120	3220
G05-1	GIEBELDECKLEISTEN - GABLE COVER STRIPS 18x40		✓	2	18x40	3202
T02-1	TRAUFBRETTER - EAVES BOARDS 18x120			1	18x120	3236
T01-1	TRAUFBRETTER - EAVES BOARDS 18x95			1	18x95	3200
T04-1	TRAUFENDECKLEISTEN - EAVES COVER STRIPS 18x40		✓		18x40	3.5 lfm/rm
T06-1	TRAUFENLEISTEN - EAVES STRIPS 18x40		✓		18x40	7.0 lfm/rm
SH	SCHLAGHÖLZER - MOUNTING PIECES			3		
NG2 550	NÄGEL - NAILS 2.5x50 Dachbretter - Roof boards			290		
SR3 030	Schrauben - Screws 3.0x30 Giebeldeckleisten - Gable cover strips			16		
SR3 030	Schrauben - Screws 3.0x30 Leiste - Lath			34		
SR3 030	Schrauben - Screws 3.0x30 Traufendeckleisten - Eaves cover strips			8		
Kood	VS28_0044 Zambezi7 300x300_28		Materjal		Leht 1/3	





Uks  
Door  
Tür

Q1 - koostamisjuhised  
Q1 - assembly instructions  
Q1 - Montageanleitung

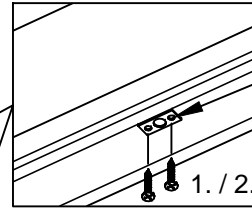

Ø8-10

5x90

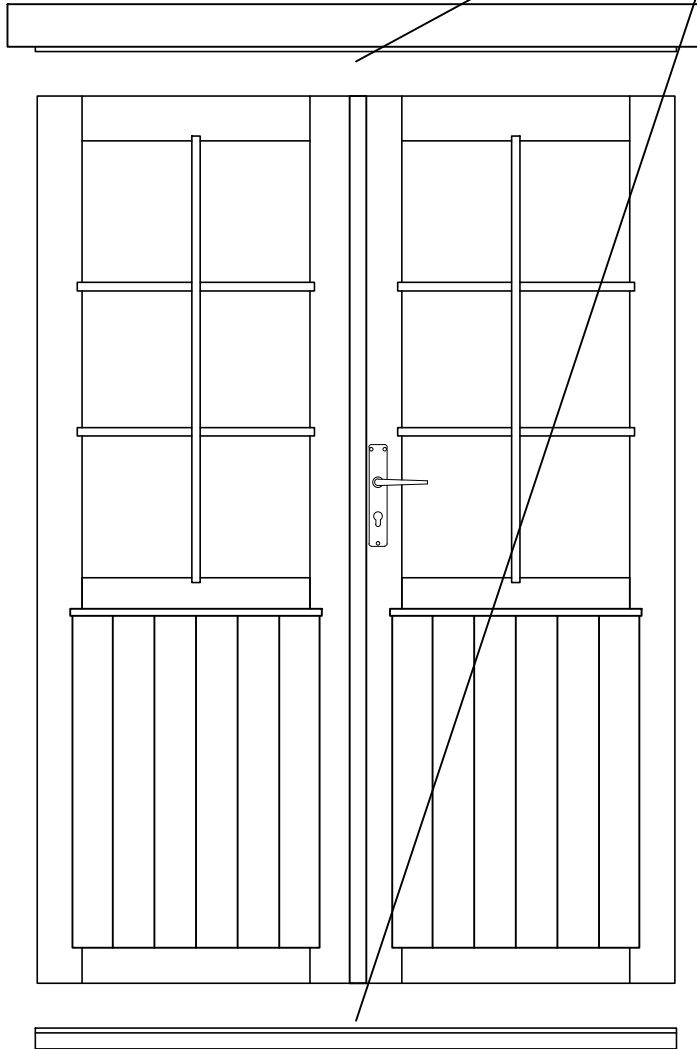
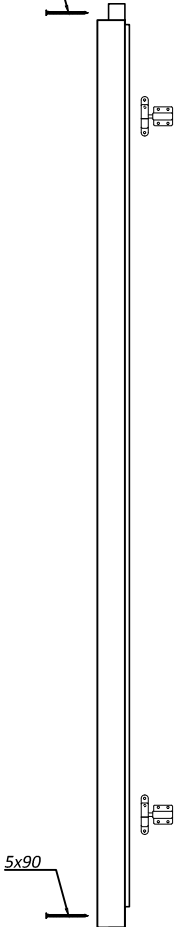

5x90

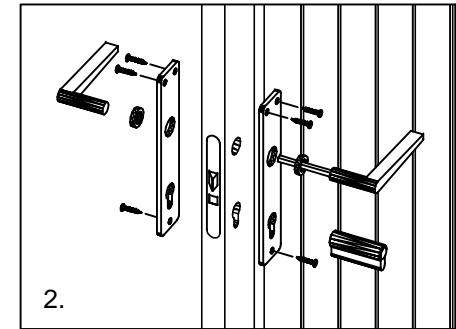
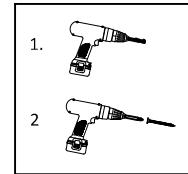
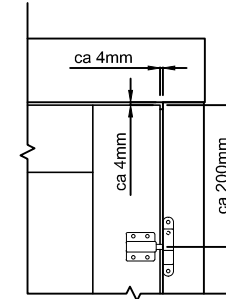
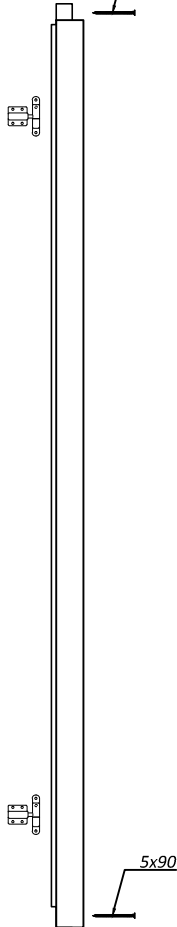

3,5x25  
4x4 pcs

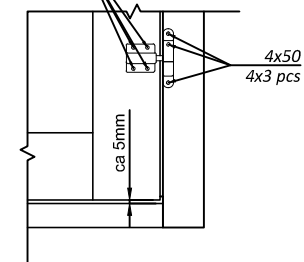

5x90

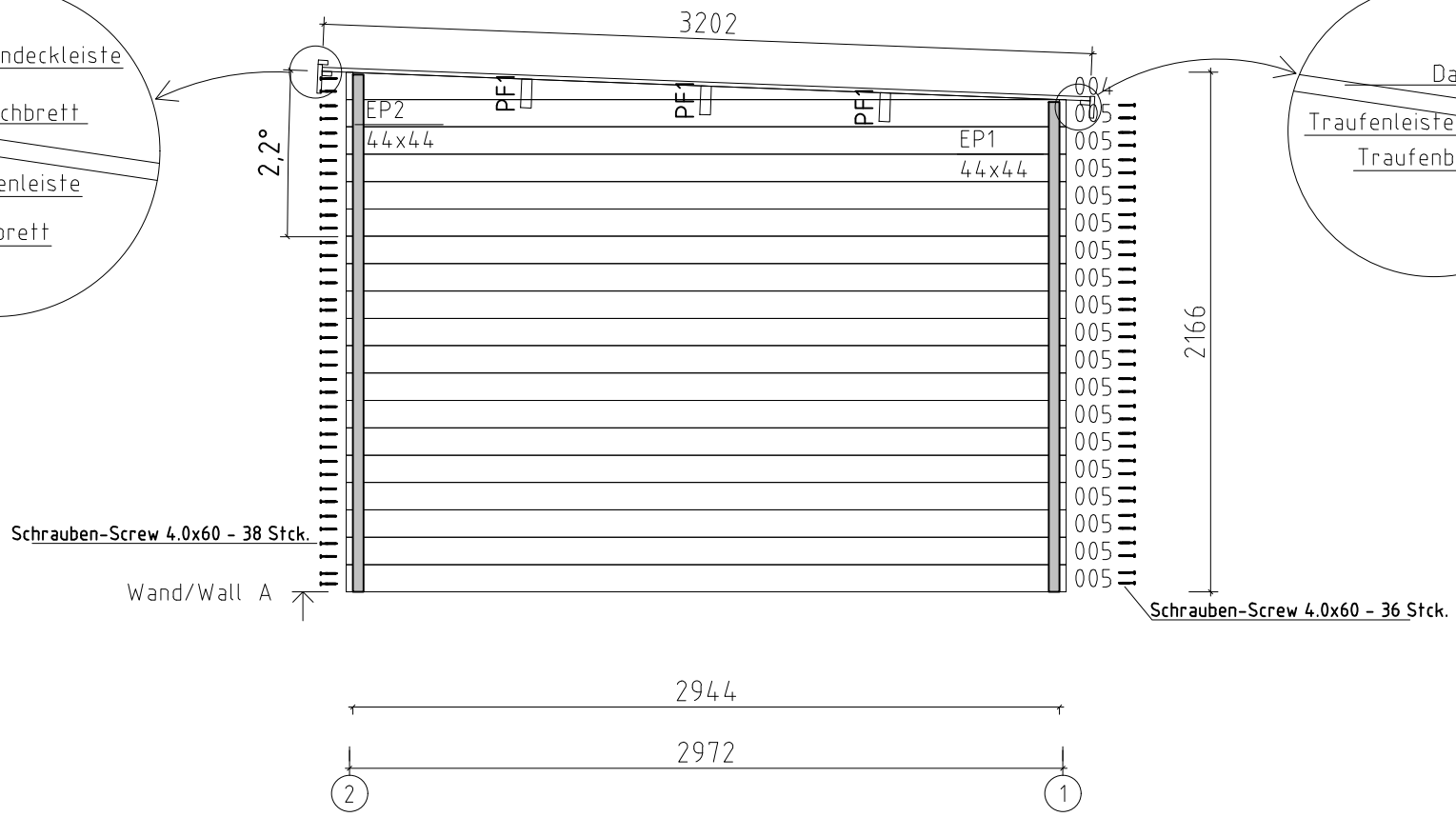
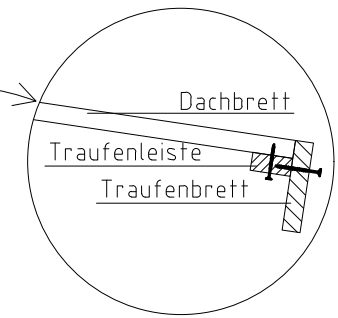
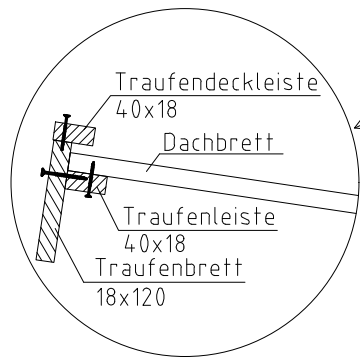

Name	VS28_0044 Zambezi7 300x300_28		
Zeichnung/Drawing	WAND/WALL A		
Profil/Profile	2.8x11.4	Datum/Date	26.01.2024



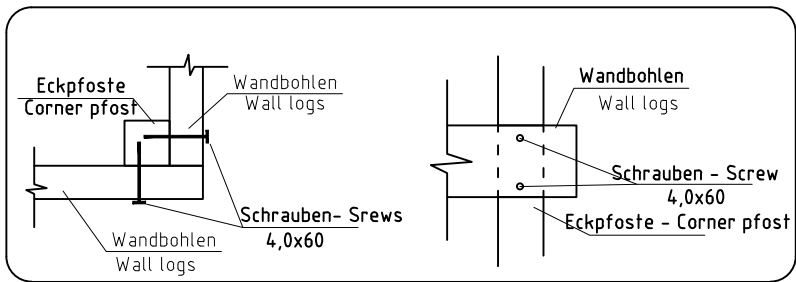
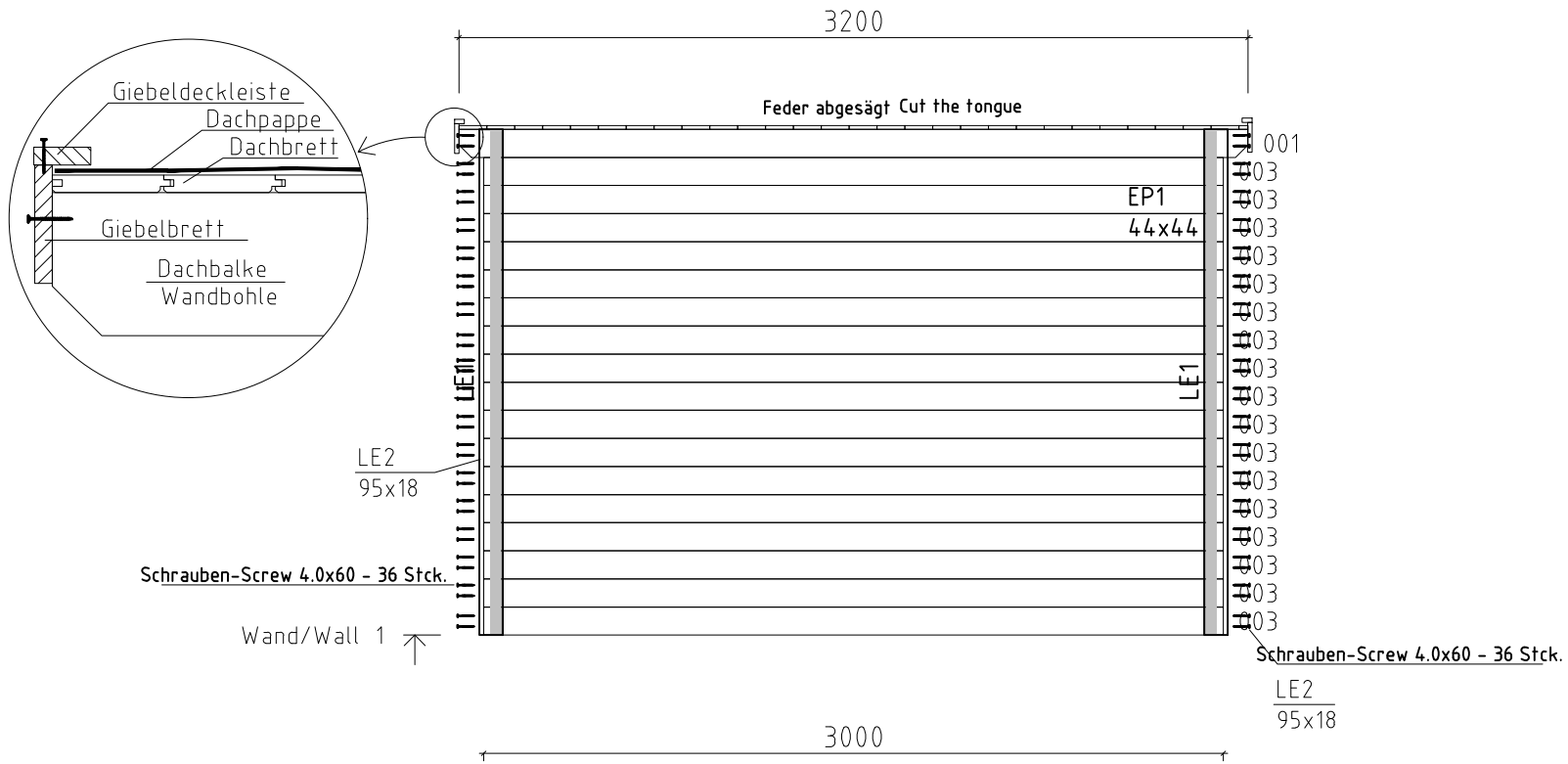

Name	VS28_0044 Zambezi7 300x300_28	
Zeichnung/Drawing	WAND/WALL 1	
Profil/Profile	2.8x11.4	Datum/Date 26.01.2024

