

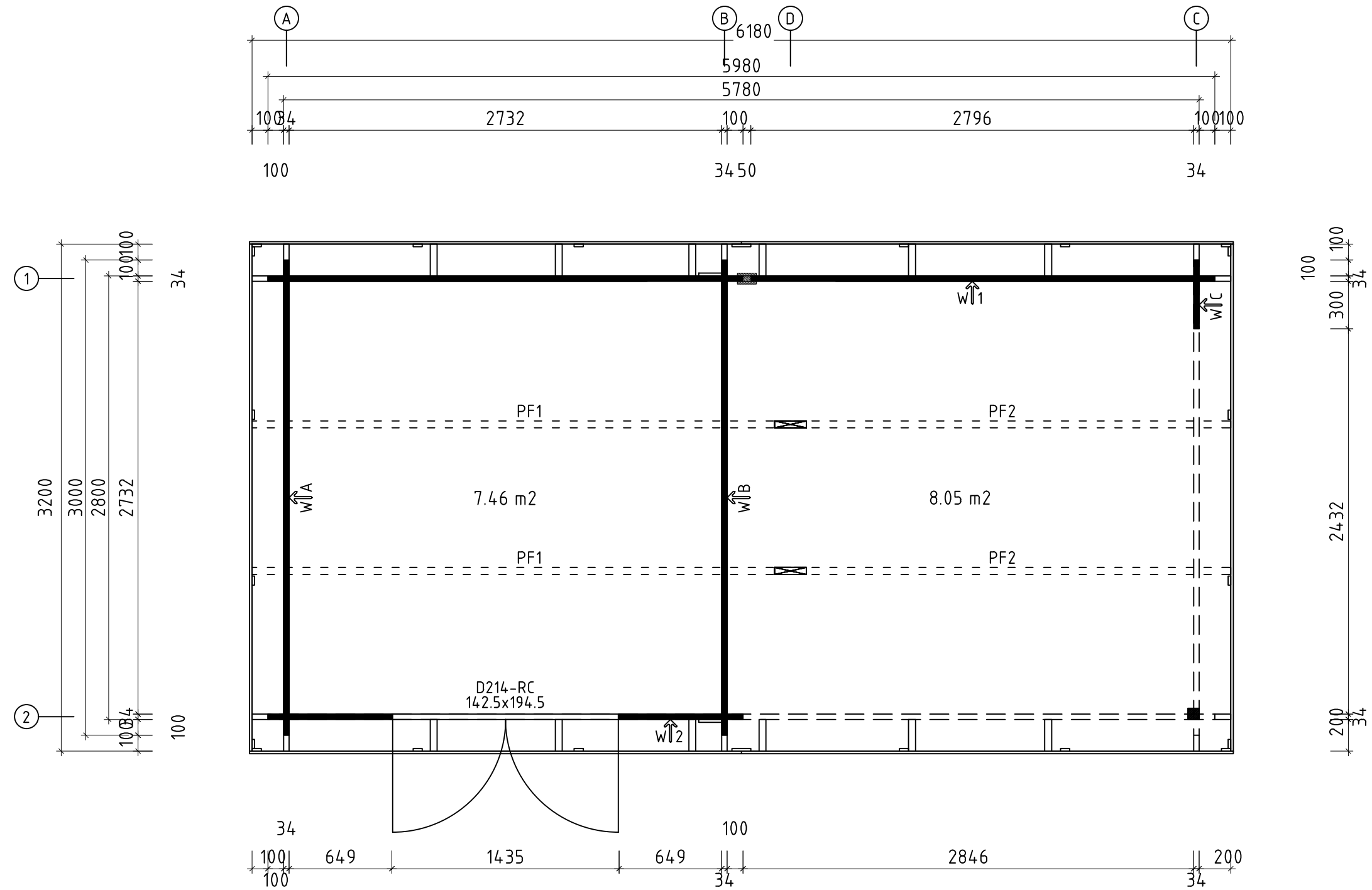

Name	VS34_0014 Carcassonne B 300x300+SD_34		
Zeichnung/Drawing	3D		
Profil/Profile	3.4x11.4	Datum/Date	02.02.2024







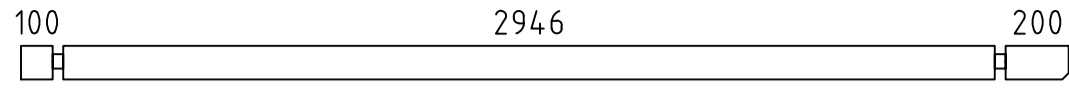
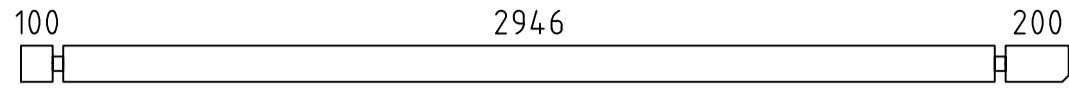
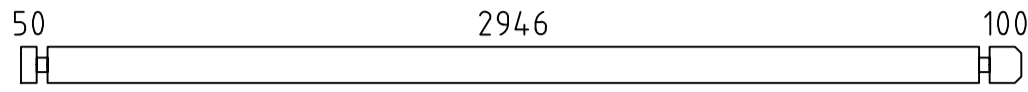
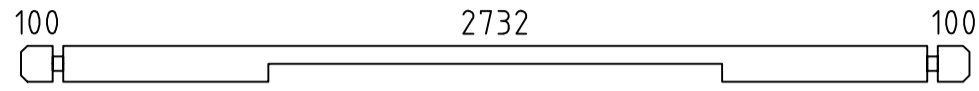
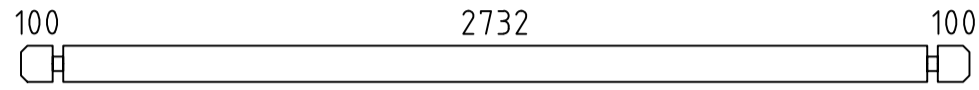
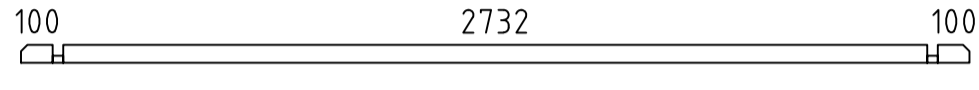
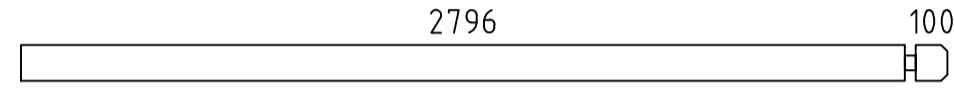
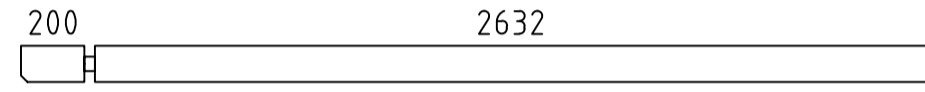
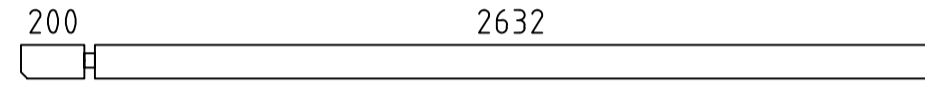
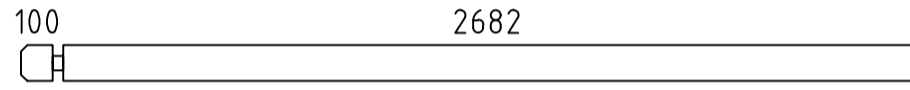
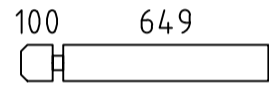
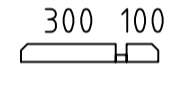
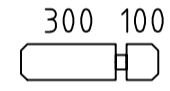
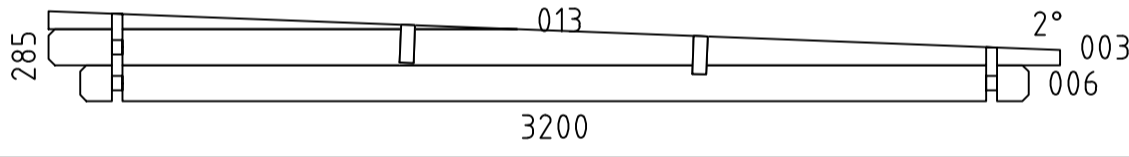
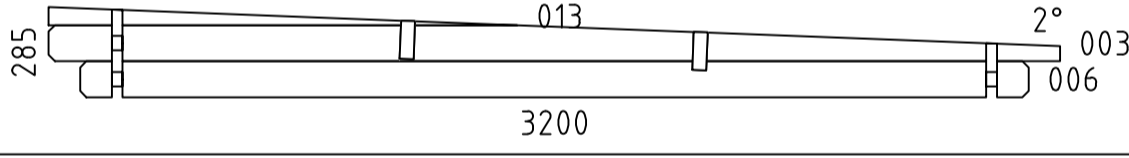
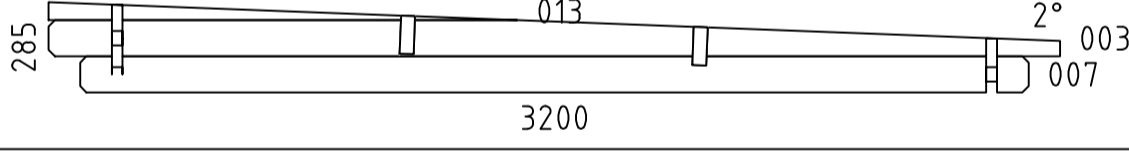
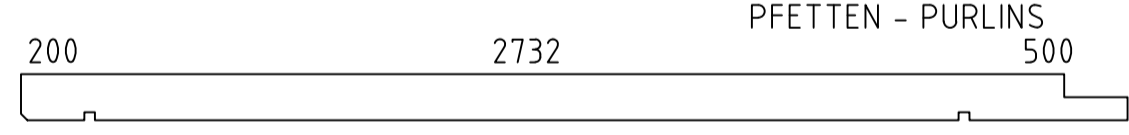
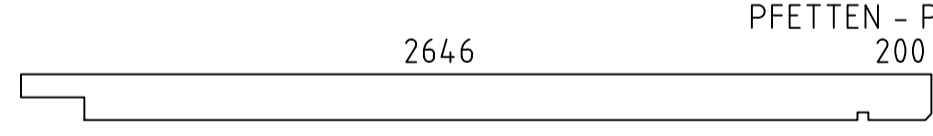
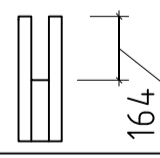
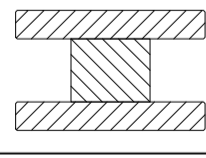
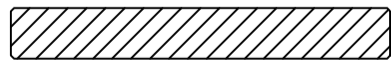

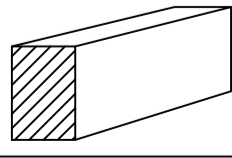
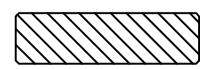

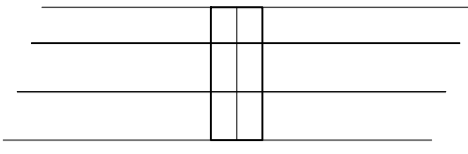
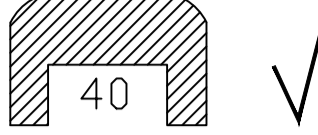

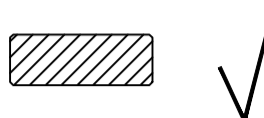
Q2 – Qualitätsklasse für Fenster und Türen/
Quality class for windows and doors

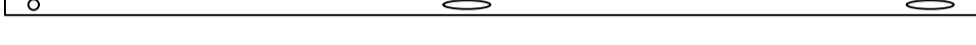
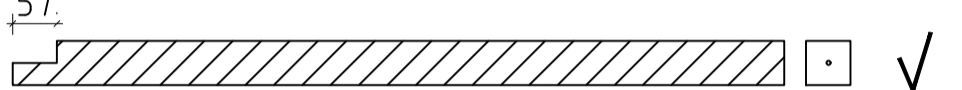
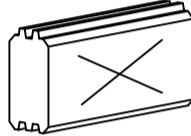
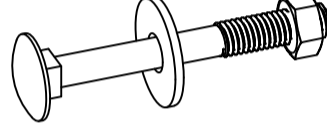
* Fenster und Türen sind mit Sprossen/
Windows and doors are with muntins

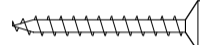
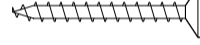
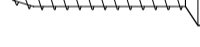
Name	VS34_0014 Carcassonne B 300x300+SD_34		
Zeichnung/Drawing	Grundplan_Plan		
Profil/Profile	3.4x11.4	Datum/Date	02.02.2024

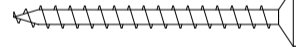
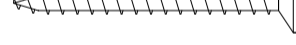
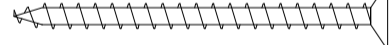
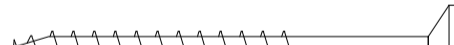
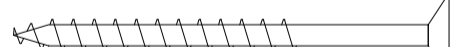
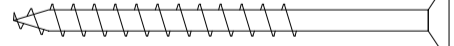
Pos	Teileliste/Specification VS34_0014 Carcassonne B 300x300+SD_34		Stck Pcs.	Profil Profile (mm)	Länge Length (mm)		
001			1	34x106	3314		
002			1	34x114	3314		
004			2	34x114	3164		
005			1	34x114	3000		
006			51	34x114	3000		
008			2	34x57	3000		
009			17	34x114	2930		
010			1	34x114	2866		
011			1	34x106	2866		
012			2	34x114	2816		
014			34	34x114	783		
015			1	34x57	434		
016			17	34x114	434		
WA-1			1				
WB-1			1				
WC-1			1				
LE1	LEISTE - LATH		2	145x18	342		
PF1		PFETTEN - PURLINS	2	44x145	3500		
PF2		PFETTEN - PURLINS	2	44x145	2880		
	DACHBRETTER - ROOF BOARDS		55+1	113x16	3102		
A34-1	ADAPTER 34	Obere Seite Upper side			1	120x70	2052
BB-1	DACHBLENDEN- Blendenbretter - PARAPET- boards 16x120			8	16x120	3106	
BB-2	DACHBLENDEN- Blendenbretter - PARAPET- boards 16x120			4	16x120	3200	
BS-1	DACHBLENDEN- Blendenstützen - PARAPET- Parapet support 44x65			12	44x65	200	
MB-1	DACHBLENDEN- Montagebrett - PARAPET- mounting board 58x16			20	58x16	250	
Kood	VS34_0014 Carcassonne B 300x300+SD_34		Materjal		Leht 1/3		

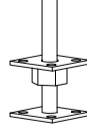
Pos	Teilleiste/Specification VS34_0014 Carcassonne B 300x300+SD_34		Stck Pcs.	Profil Profile (mm)	Länge Length (mm)
VL-1	DACHBLENDEN- Verbindungsleisten - PARAPET- connecting strips 120x16		2	16x120	250
UPB-1	DACHBLENDEN- U-Profil für Blenden - PARAPET- U-Profile			65x44	19.0 lfm/rm
DPL-1	DACHPAPPENLEISTEN - ROOFING FELT STRIPS 15x28			15x28	12.0 lfm/rm
TL01-1	TRAUFENLEISTEN - EAVES STRIPS 16x45			16x45	12.0 lfm/rm
SM-1	Sturmleisten - Storm reinforcement		2	18x40	2052
SM-2	Sturmleisten - Storm reinforcement		2	18x40	2166
TP68-1	STÜTZPFOSTE - SUPPORT POST 68x68		1	68x68	2052
SH	SCHLAGHÖLZER - MOUNTING PIECES		3		
SS024	Schloßschrauben - Wood bolts M8x70 Mutter - Nut M8 U-Scheibe - Washer Ø25 (für Sturmleisten - storm reinforcement)		12		
NG2 550	NÄGEL - NAILS 2.5x50 Dachbretter - Roof boards		440		
SR3 030	Schrauben - Screws 3.0x30 Dachblenden Montagebrett - Parapet mounting board		80		
SR3 030	Schrauben - Screws 3.0x30 Dachblenden Verbindungsleisten - Parapet Connecting strips		16		
SR3 030	Schrauben - Screws 3.0x30 Dachpappeleisten - Roofing felt		24		
SR3 030	Schrauben - Screws 3.0x30 Traufenleisten - Eaves strips		24		
SR3 545	Schrauben - Screws 3.5x45 Leiste - Lath		24		
SR3 545	Schrauben - Screws 3.5x45 U-Profil für Blenden - Parapet U-Profile		38		
SR4 060	Schrauben - Screws 4.0x60 Stützpfoste - Support post		2		
SR5 070	Schrauben - Screws 5.0x70 Blendenbefestigung - Parapet mounting		64		
SR5 070	Schrauben - Screws 5.0x70 Blendenstützen - Parapet support		28		
SR507 0-002	Schrauben - Screws 5.0x70 Verstellbare pfostenstütze - Post support		4		
SR62	Schrauben - Screws 6.0x140 (ASSY für Pfetten - for purlins)		4		
VP1	Verstellbare Pfostenstütze - Adjustable post support M10		1		
	✓ - Bitte selber anpassen (falls nötig)! / Cut into length on site (if needed)!				
Kood	VS34_0014 Carcassonne B 300x300+SD_34	Materjal		Leht	2/3

DACHBLENDEN (Montage) - PARAPET (Mounting)

DACHBLENDEN 1a - PARAPET 1a

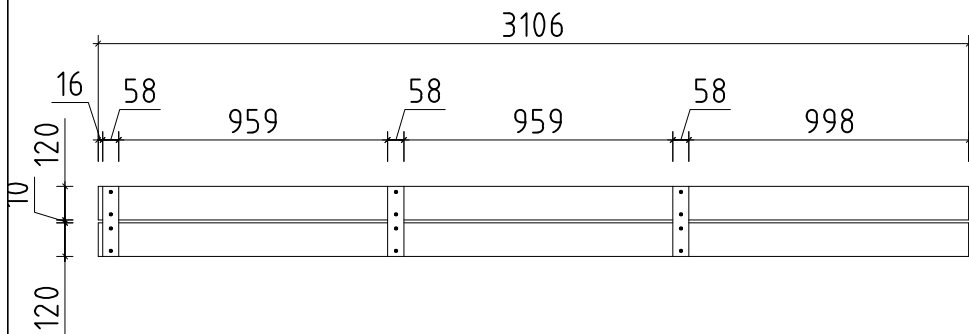

DACHBLENDEN 1b - PARAPET 1b

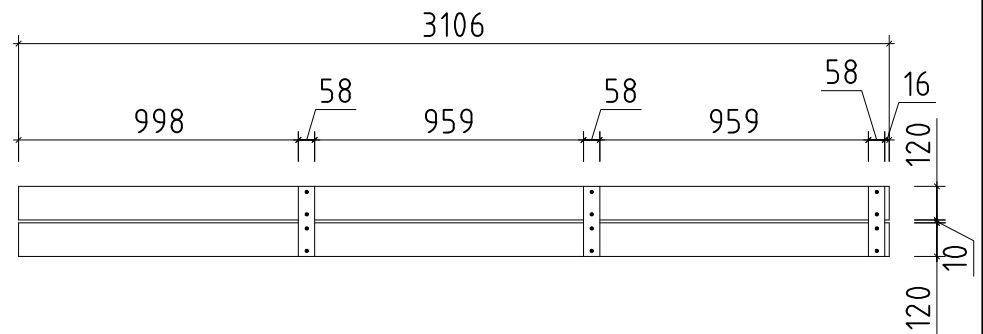

DACHBLENDEN 1 - PARAPET 1

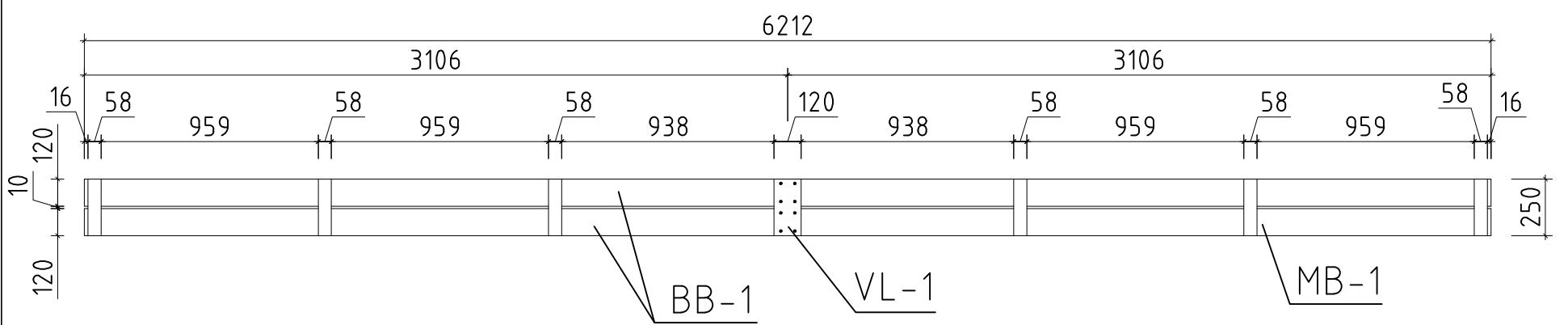

DACHBLENDEN 2 - PARAPET 2

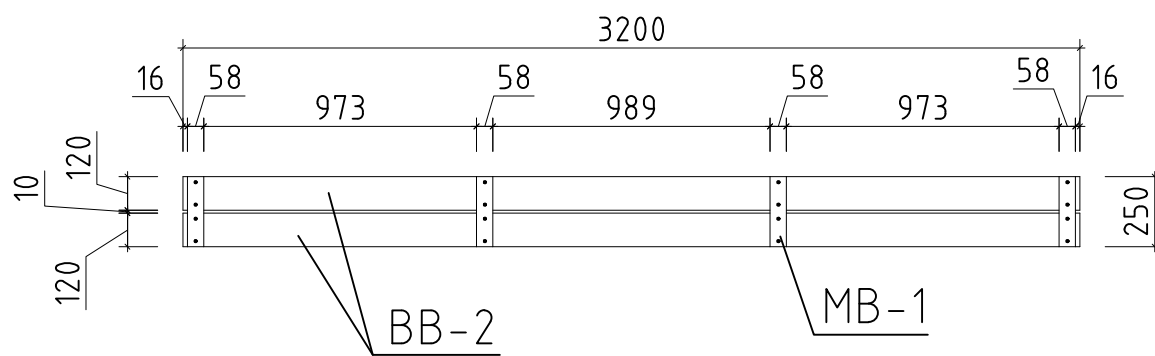

Pärilinite ühendamine / Verbinden der Pfetten / Connecting purlins

1

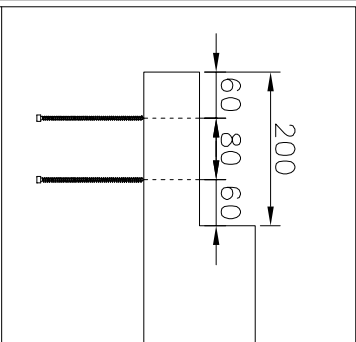

Märkige kruvide asukohad /
Markieren Sie die empfehlenden
Schraubenpositionen /
Mark the suggested positions
for screws

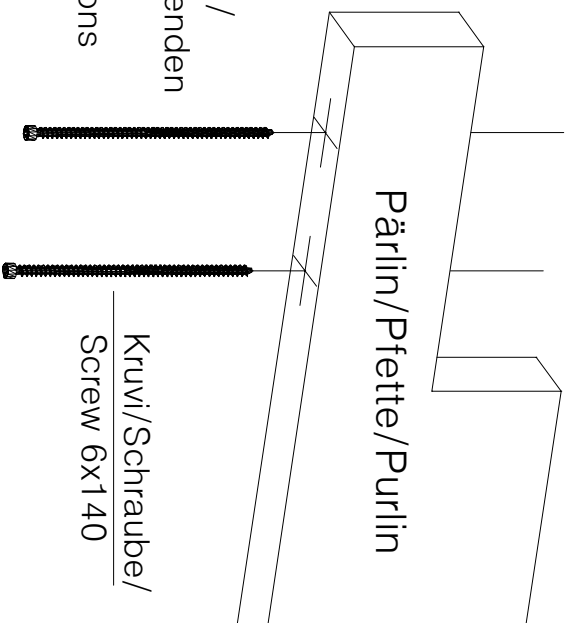

2

Keerake kruvid poole ulatuses sisse.
(Vaja läheb Assy AW30 või Torx T30 otsikut) ☆
Drehen Sie die Schrauben bis zur Hälfte
seiner Länge ein.

(Für diese Schrauben benötigen Sie einen
Assy AW30 oder Inrentorx T30
Schraubereinsatz) ☆

Turn the screws up
until the first half.

(These screws require Assy AW30
or Torx T30 driver bit) ☆

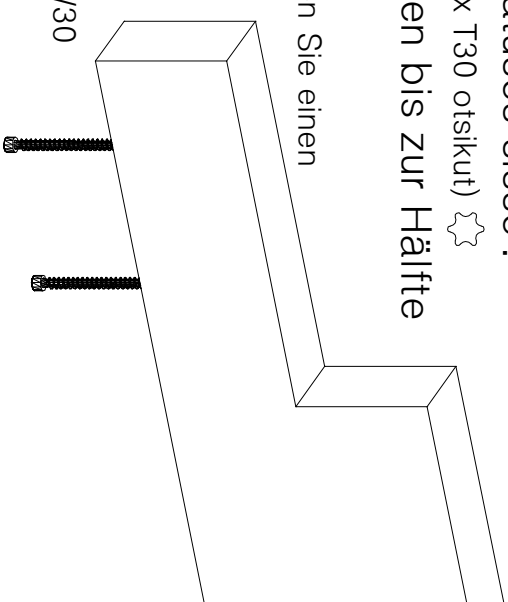

3

Hoja ühendatavad pärilnid tihedalt koos /
Setzen Sie die Enden der Balken zusammen /
Keep purlins tight together

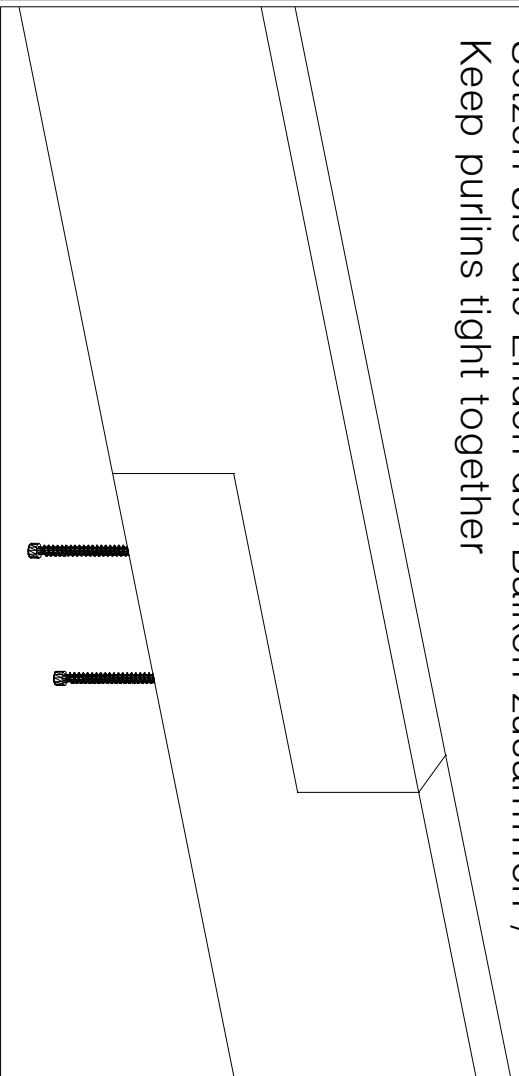

4

Keera kruvid lõpuni sisse /
Drehen Sie die Schrauben dann ganz ein /
Turn the screws up until the end

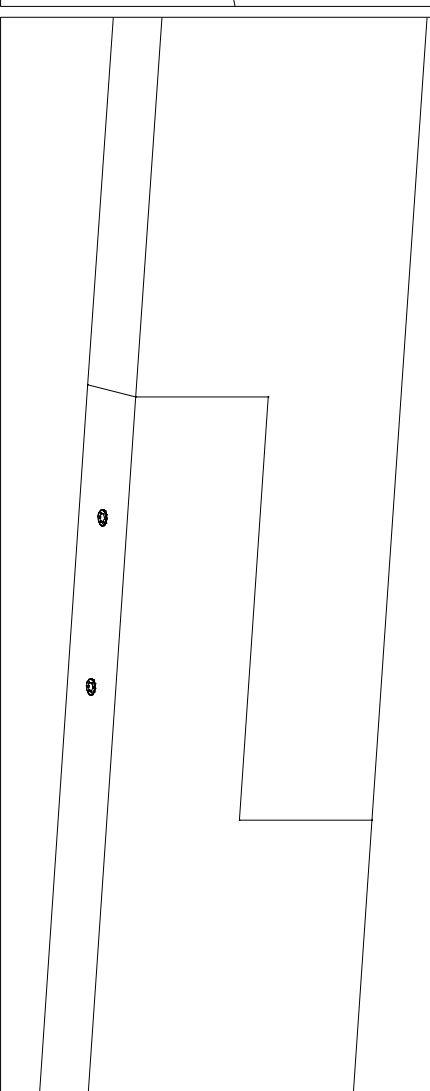

Uks	Q2-Q3	-	koostamisjuhhis
Door	Q2-Q3	-	assembly instructions
Tür	Q2-Q3	-	Montageanleitung

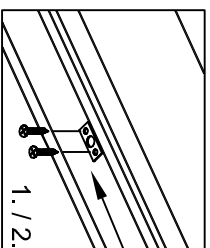
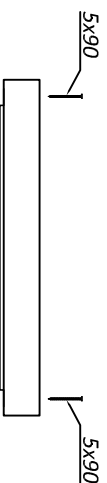

Ø8-10

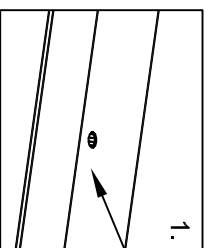
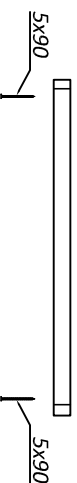
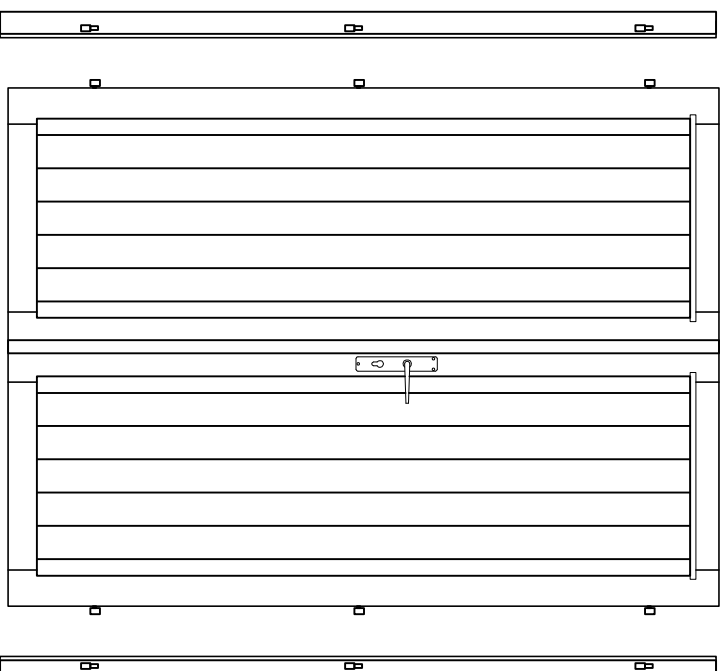
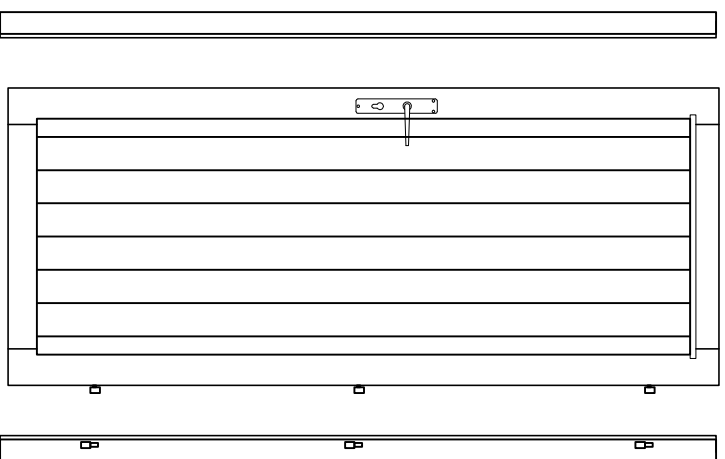
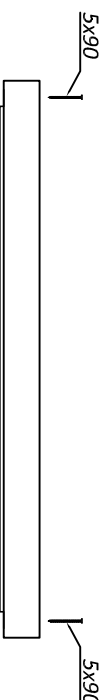

Ø8-10

*Kui ühepoolne uks ei ole kokku pandud!
 *When single door is not assembled!
 *Wenn Einzeltür ist nicht zusammengebaut!

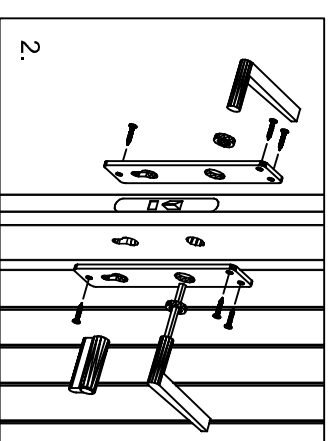
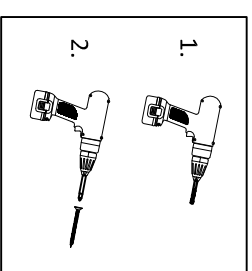

*Kui hinged ei ole paigaldatud!
 *When hinges are not attached!
 *Wenn Scharniere sind nicht angebracht!

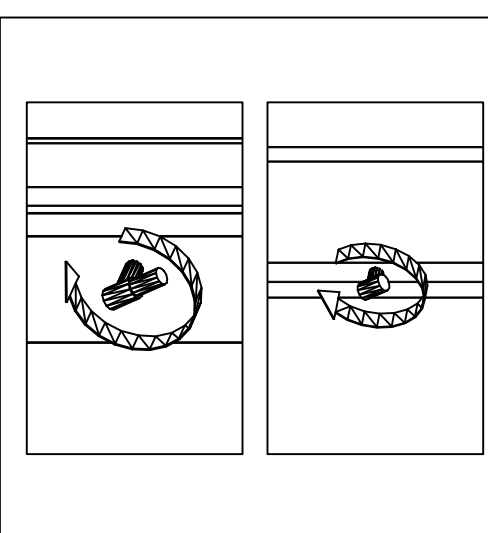

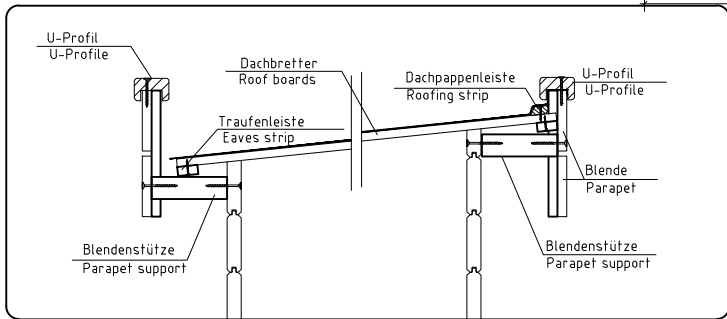
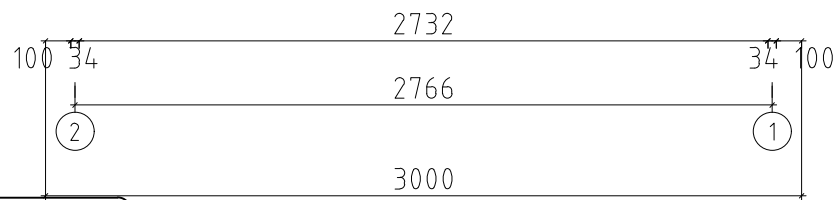
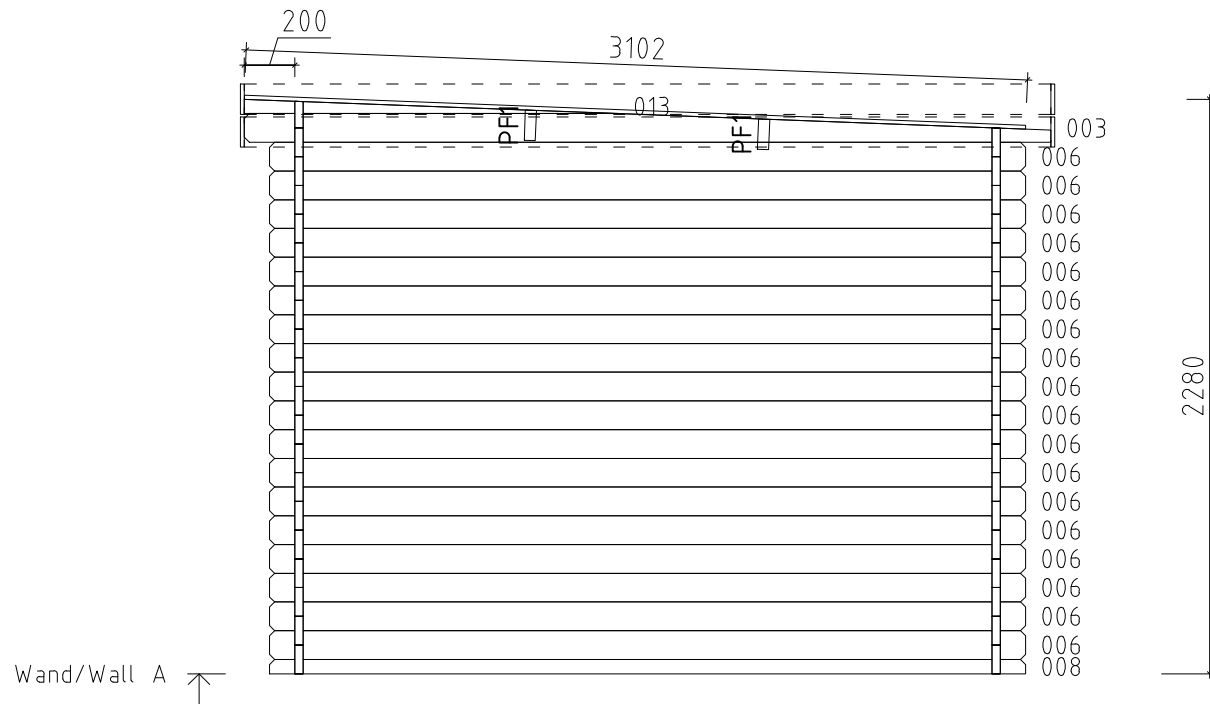

Name	VS34_0014 Carcassonne B 300x300+SD_34		
Zeichnung/Drawing	WAND/WALL A		
Profil/Profile	3.4x11.4	Datum/Date	02.02.2024

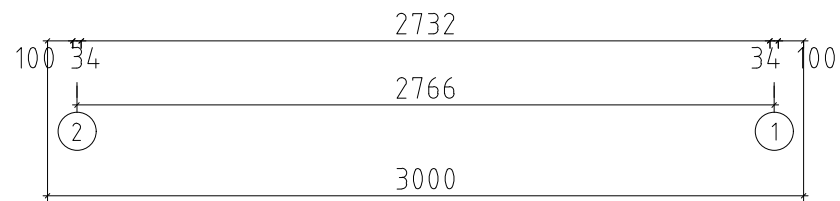
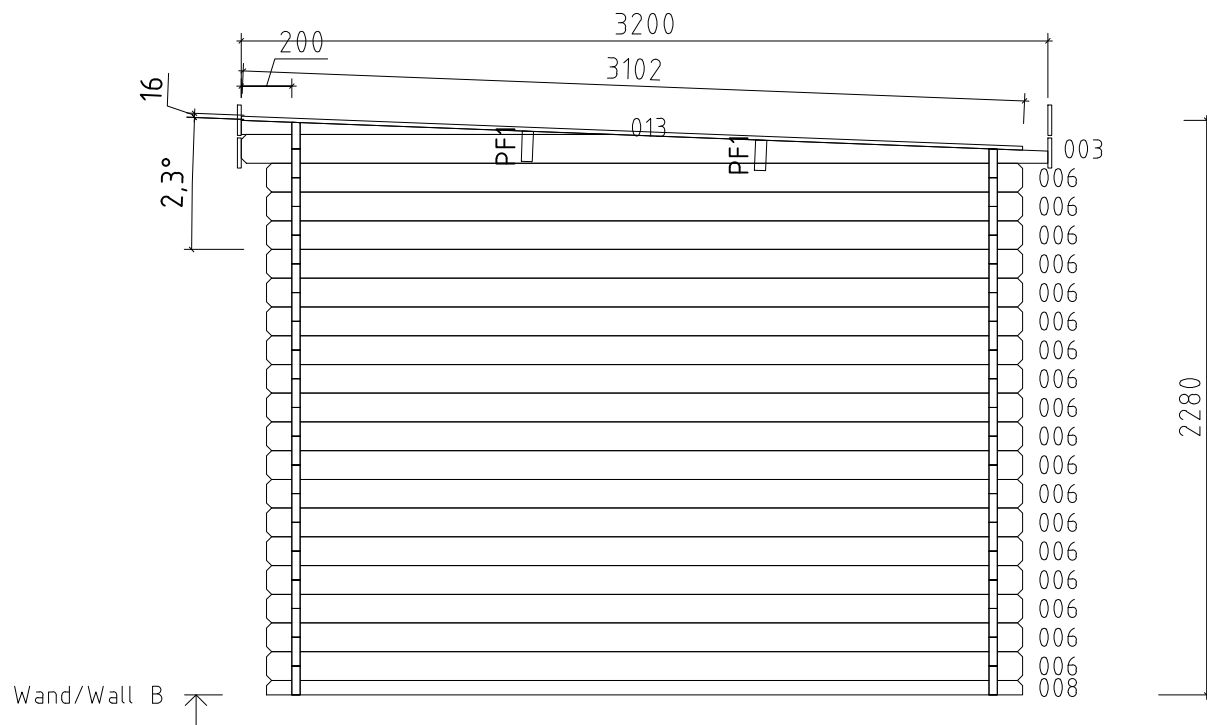

Name	VS34_0014 Carcassonne B 300x300+SD_34		
Zeichnung/Drawing	WAND/WALL B		
Profil/Profile	3.4x11.4	Datum/Date	02.02.2024

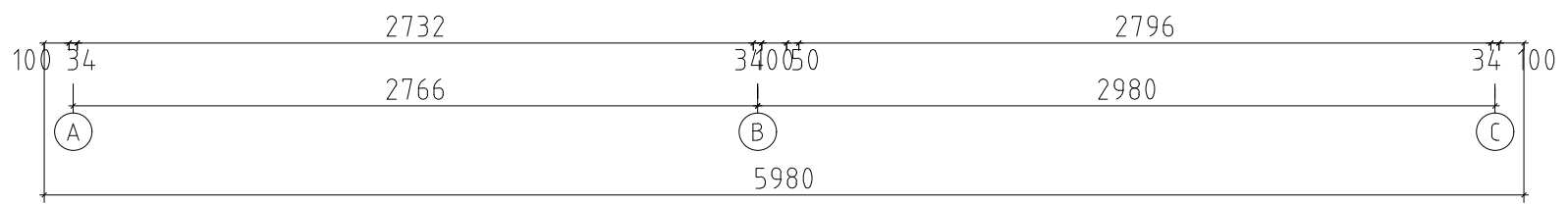
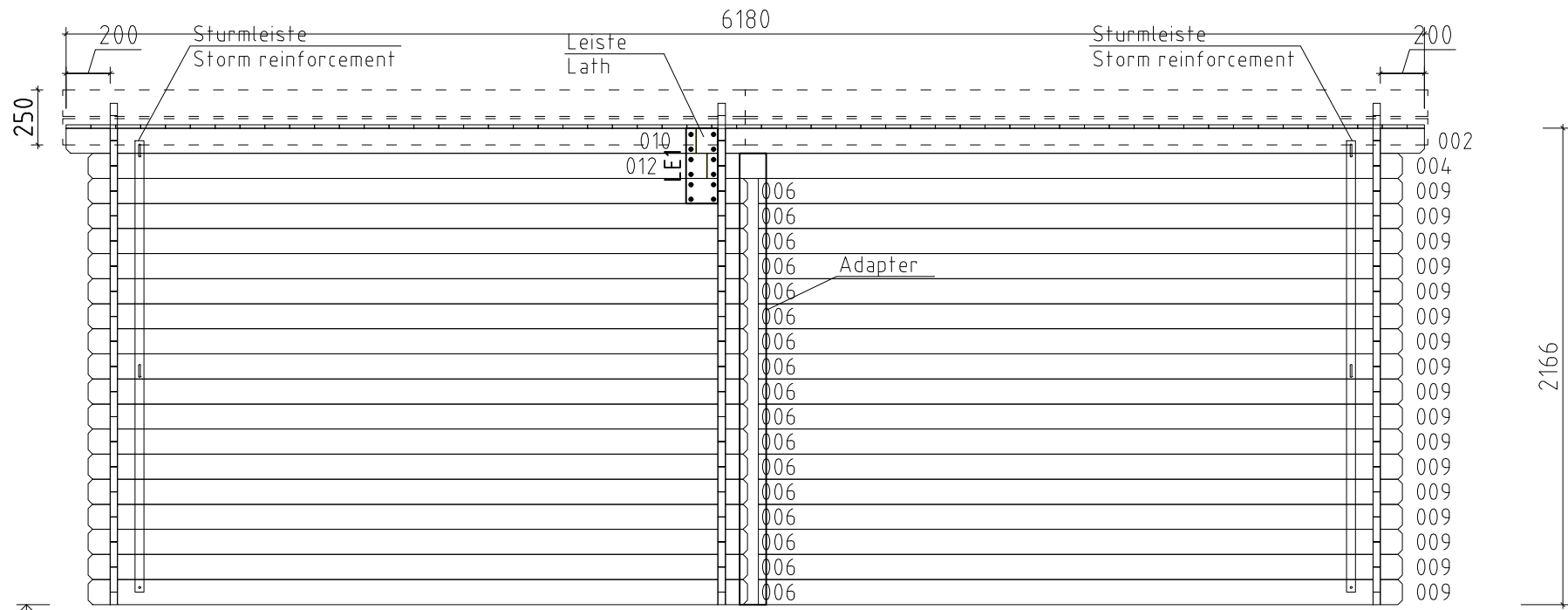

Name	VS34_0014 Carcassonne B 300x300+SD_34		
Zeichnung/Drawing	WAND/WALL 1		
Profil/Profile	3.4x11.4	Datum/Date	02.02.2024

